

ECONOMY SPLASHBACK BENCH 610mm DEEP



This 610 mm splashback bench range is modular to the Brayco 610 mm deep flat benches and cabinet.

610 SERIES SPLASHBACK BENCH

Overall Dimensions:

900 (w) x 610 (d) x 900 mm (h)

Splashback Height: 150 mm

Loading Capacity:

Top: 150kg, Undershelf: 80kg

Shipping Dimensions:

Bench: 940 x 650 x 250mm

Legs: 880 x 90 x 40mm

Shipping Weight: 20.7kg

Material:

Top: 1.2 mm 430 stainless steel

Undershelf: 1.2 mm galvanised steel

Legs: 1.2 mm galvanised steel

FRONT

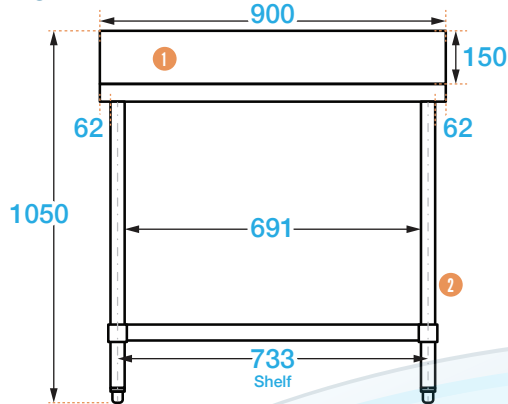

SIDE

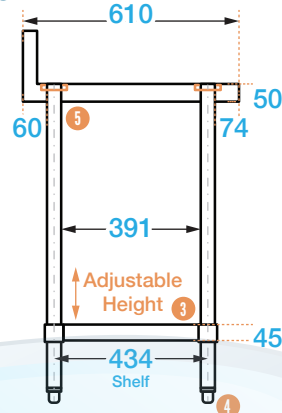

TOP

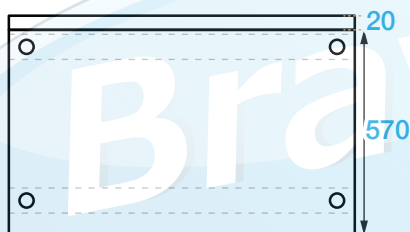

COMPONENTS

- 1 Splashback
150 mm (high)
20 mm (deep)
- 2 Legs
Ø 42.5 mm
- 3 Adjustable undershelf
1.2 mm
- 4 Adjustable feet
Adjust up to 18 mm
- 5 Welded socket
1.2 mm



It is important that your stainless steel is kept clean to extend the lifetime of the product.

LEG UPGRADES

- **410 Grade Stainless Legs & Feet:**
304 grade stainless steel benches standard legs. Adjustable up to 18 mm.
- **201 Grade Stainless Legs & Feet:**
For extremely salty or chemical conditions. Adjustable up to 38 mm.
- **410 Grade Stainless Legs & Lockable Castors**
- **201 Grade Stainless Legs & Lockable Castors:**
For extremely salty or chemical conditions.
- **410 Grade Stainless Steel Legs & Screw Down Feet:**
Adjustable up to 20 mm.
- **201 Grade Stainless Steel Legs & Screw Down Feet:**
For extremely salty or chemical conditions. Adjustable up to 20 mm.

PRODUCT CODE: ECO9061SP



Brayco Stainless Steel is made from 95% recycled materials

FEATURES AND BENEFITS

- Galvanised adjustable Height Undershelf.
- 430 Grade Stainless Steel Top.
- Supplied Flat Pack: Simple assembly required.
- Construction: Our units are fully stainless steel with round legs.
- Adjustable Feet: Supplied attached to leg. See additional items below for upgrade options.

ADDITIONAL ITEMS

- **430 Grade Stainless Undershelf:**
For extremely salty or chemical conditions.
- **Overshelves:**
2 tier overshelves sit on top of bench.
- **Leg Brace Rail Kit:**
Remove the undershelf and add a rail kit for extra strength.
- **Leg attachments:** Enclose your bench by attaching panels.
- Extra shelves also available

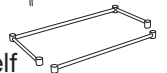

Brisbane • Sydney • Melbourne • Hobart • Adelaide • Perth • Auckland

For more info please contact your nearest Brayco Branch 1300 272 926 | brayco.com.au