

DOUBLE SINK WITH LEFT HAND BENCH



This 610 mm sink range is modular to the Brayco 610 mm deep cabinets, benches and splashback benches.



610 SERIES SINKS

Overall Dimensions:

1500 (w) x 610 (d) x 1050 mm (h)

Bowl Size:

500 (w) x 400 (d) x 300 mm (h) ea

Capacity: 60 L ea

Shipping Dimensions:

Sink: 1500 (w) x 610 (d) x 460 mm (h)

Legs: 1370 (w) x 170 (d) x 100 mm (h)

Shipping Weight: 33.55 kg

Material:

Top: 1.2 mm 304 grade stainless steel

Legs: 201 grade 42.5 mm diameter stainless steel

FRONT

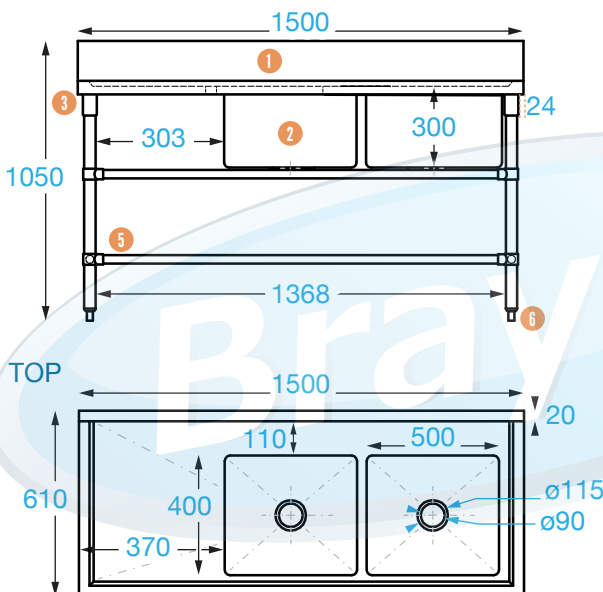

SIDE

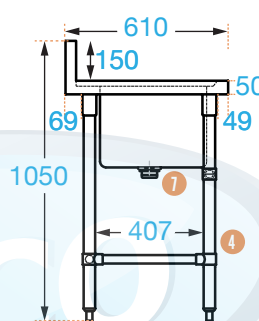

TOP

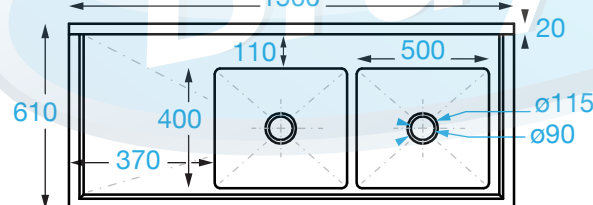

COMPONENTS

- 1 Splashback
- 2 Fully welded bowls
- 3 Welded sockets
- 4 Stainless legs
- 5 Rails (back, front & side)
- 6 Adjustable feet
- 7 Waste outlet

DIMENSIONS

- 150 mm (high), 20 mm (deep)
- 60 ltr capacity each
- 1.2 mm
- Ø 42.5 mm
- Ø 32 mm
- up to 35 mm (max)
- 90 mm (diameter)

PRODUCT CODE: DSL610-15





Brayco Stainless Steel is made from 95% recycled materials

FEATURES AND BENEFITS

- Sink Drainer Included.
- Construction: Our units are fully stainless steel. Very sturdy.
- Bowl: Fully welded for strength and superior durability.
- Tap Location: Untapped to allow for universal plumbing as required.
- Bar work: Fully adjustable.
- Supplied Flat Packed: Simple assembly, instructions included.

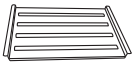
OPTIONS

- **Splashback Extension:**  Convert your sink to a corner unit.
- **Slatted Sink Cover:** Ideal drainer tray or to rinse food.  Code: SCH400
- **Sink Cover:** Create extra work space.  Code: SCB400
- **Under-sink shelf:** 650 mm long stainless steel shelf.

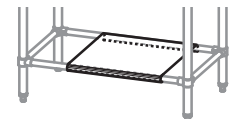

Code: SHELFSSINK610



It is important that your stainless steel is kept clean to extend the lifetime of the product.



Brisbane • Sydney • Melbourne • Hobart • Adelaide • Perth • Auckland
For more info please contact your nearest Brayco Branch 1300 272 926 | brayco.com.au