

FLAT BENCHES 914mm DEEP WIDER ISLAND



914 SERIES FLAT BENCH

Overall Dimensions:

2438 (w) x 914 (d) x 900 mm (h)

Loading Capacity:

Top: 380 kg, Undershelf: 120 kg

Shipping Dimensions:

2480 (w) x 960 (d) x 105 mm (h)

Shipping Weight: 75 kg

Material:

Top: 1.2 mm 304 grade stainless steel

Undershelf: 1.5 mm galvanised steel

Legs: 410 grade 42.5 mm diameter

Welded stainless steel



FRONT

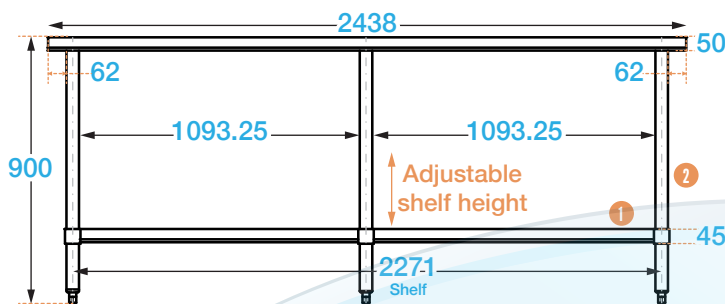

SIDE

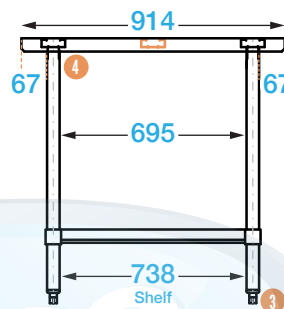

REINFORCED BENCH TOPS

914 mm deep benches of 914 mm to 2438 mm length feature a third bar that ensures bench top strength and stability.

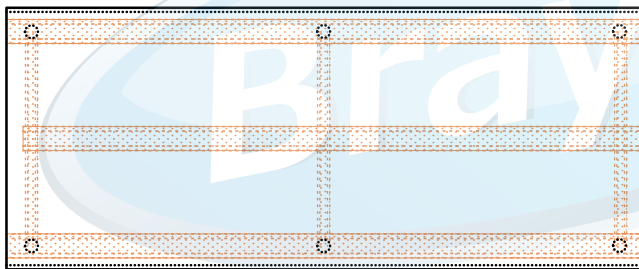

COMPONENTS

- 1 Galvanised undershelf
1.5 mm (height adjustable)
- 2 Stainless steel legs
Ø 42.5 mm
- 3 Adjustable feet
Adjustable up to 18 mm
- 4 Welded sockets
1.2 mm



It is important that your stainless steel is kept clean to extend the lifetime of the product.

LEG UPGRADES

- 201 Grade Stainless Legs & Feet:
For extremely salty or chemical conditions. Feet adjust up to 38 mm.
- 410 Grade Stainless Legs & Lockable Castors
- 201 Grade Stainless Legs & Lockable Castors: For extremely salty or chemical conditions.
- 410 Grade Stainless Steel Legs & Screw Down Feet:
Adjustable up to 20 mm.
- 201 Grade Stainless Steel Legs & Screw Down Feet:
Adjustable up to 20 mm.

PRODUCT CODES: 3696



Brayco Stainless Steel is made from 95% recycled materials

FEATURES AND BENEFITS

- Adjustable Height Undershelf.
- High Grade Stainless Steel.
- Supplied Flat Pack: Simple assembly required.
- Construction: Our units are fully stainless steel with round legs.
- Adjustable Feet: Supplied attached to leg. See additional items below for upgrade options.

ADDITIONAL ITEMS

- 430 Grade Stainless Undershelf:
For extremely salty or chemical conditions.

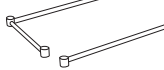
- Leg Brace Rail Kit:  Remove the undershelf and add a rail kit for extra strength. Allows for extra storage such as a dishwasher, washing machine, etc.

- Lockable Drawers:  Add a unit with 1 or 2 lockable drawers.

- Leg attachments: Enclose  your bench by attaching panels.

- Overshelves: 2 tier overshelves sit on top of bench.

- Extra shelves also available 



Brisbane • Sydney • Melbourne • Hobart • Adelaide • Perth • Auckland

For more info please contact your nearest Brayco Branch 1300 272 926 | brayco.com.au